

ASUS®

PA278QV/PA278QEV

Series LCD Monitor

User Guide

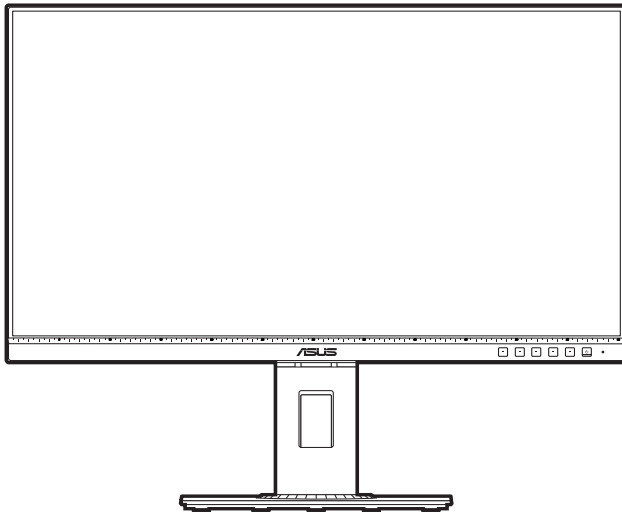

HDMI™
HIGH-DEFINITION MULTIMEDIA INTERFACE

First Edition

March 2020

Copyright © 2020 ASUSTeK COMPUTER INC. All Rights Reserved.

No part of this manual, including the products and software described in it, may be reproduced, transmitted, transcribed, stored in a retrieval system, or translated into any language in any form or by any means, except documentation kept by the purchaser for backup purposes, without the express written permission of ASUSTeK COMPUTER INC. ("ASUS").

Product warranty or service will not be extended if: (1) the product is repaired, modified or altered, unless such repair, modification or alteration is authorized in writing by ASUS; or (2) the serial number of the product is defaced or missing.

ASUS PROVIDES THIS MANUAL "AS IS" WITHOUT WARRANTY OF ANY KIND, EITHER EXPRESS OR IMPLIED, INCLUDING BUT NOT LIMITED TO THE IMPLIED WARRANTIES OR CONDITIONS OF MERCHANTABILITY OR FITNESS FOR A PARTICULAR PURPOSE. IN NO EVENT SHALL ASUS, ITS DIRECTORS, OFFICERS, EMPLOYEES OR AGENTS BE LIABLE FOR ANY INDIRECT, SPECIAL, INCIDENTAL, OR CONSEQUENTIAL DAMAGES (INCLUDING DAMAGES FOR LOSS OF PROFITS, LOSS OF BUSINESS, LOSS OF USE OR DATA, INTERRUPTION OF BUSINESS AND THE LIKE), EVEN IF ASUS HAS BEEN ADVISED OF THE POSSIBILITY OF SUCH DAMAGES ARISING FROM ANY DEFECT OR ERROR IN THIS MANUAL OR PRODUCT.

SPECIFICATIONS AND INFORMATION CONTAINED IN THIS MANUAL ARE FURNISHED FOR INFORMATIONAL USE ONLY, AND ARE SUBJECT TO CHANGE AT ANY TIME WITHOUT NOTICE, AND SHOULD NOT BE CONSTRUED AS A COMMITMENT BY ASUS. ASUS ASSUMES NO RESPONSIBILITY OR LIABILITY FOR ANY ERRORS OR INACCURACIES THAT MAY APPEAR IN THIS MANUAL, INCLUDING THE PRODUCTS AND SOFTWARE DESCRIBED IN IT.

Products and corporate names appearing in this manual may or may not be registered trademarks or copyrights of their respective companies, and are used only for identification or explanation and to the owners' benefit, without intent to infringe.

Contents

Contents	iii
Notices	iv
TCO certified	vi
Safety information	vii
Care & Cleaning	viii
Takeback Services	ix
Product information for EU energy label	ix
Chapter 1: Product introduction	
1.1 Welcome!	1-1
1.2 Package contents	1-1
1.3 Monitor introduction	1-2
1.3.1 Front view	1-2
1.3.2 Back view	1-4
Chapter 2: Setup	
2.1 Assembling the monitor arm/base	2-1
2.2 Detaching the arm/base (for VESA wall mount)	2-2
2.3 Adjusting the monitor	2-3
2.4 Connecting the cables	2-4
2.5 Turning on the monitor	2-4
Chapter 3: General instructions	
3.1 OSD (On-Screen Display) menu	3-1
3.1.1 How to reconfigure	3-1
3.1.2 OSD function introduction	3-2
3.2 Specifications summary	3-10
3.3 Outline dimensions	3-12
3.4 Troubleshooting (FAQ)	3-13
3.5 Supported operating modes	3-14

Notices

Federal Communications Commission Statement

This device complies with Part 15 of the FCC Rules. Operation is subject to the following two conditions:

- This device may not cause harmful interference, and
- This device must accept any interference received including interference that may cause undesired operation.

This equipment has been tested and found to comply with the limits for a Class B digital device, pursuant to Part 15 of the FCC Rules. These limits are designed to provide reasonable protection against harmful interference in a residential installation. This equipment generates, uses and can radiate radio frequency energy and, if not installed and used in accordance with the instructions, may cause harmful interference to radio communications. However, there is no guarantee that interference will not occur in a particular installation. If this equipment does cause harmful interference to radio or television reception, which can be determined by turning the equipment off and on, the user is encouraged to try to correct the interference by one or more of the following measures:

- Reorient or relocate the receiving antenna.
- Increase the separation between the equipment and receiver.
- Connect the equipment into an outlet on a circuit different from that to which the receiver is connected.
- Consult the dealer or an experienced radio/TV technician for help.



The use of shielded cables for connection of the monitor to the graphics card is required to assure compliance with FCC regulations. Changes or modifications to this unit not expressly approved by the party responsible for compliance could void the user's authority to operate this equipment.

ENERGY STAR complied product



ENERGY STAR is a joint program of the U.S. Environmental Protection Agency and the U.S. Department of Energy helping us all save money and protect the environment through energy efficient products and practices.

All ASUS products with the ENERGY STAR logo comply with the ENERGY STAR standard, and the power management feature is enabled by default. The monitor and computer are automatically set to sleep after 10 and 30 minutes of user inactivity. To wake your computer, click the mouse or press any key on the keyboard. Please visit <http://www.energystar.gov/powermanagement> for detail information on power management and its benefits to the environment. In addition, please visit <http://www.energystar.gov> for detail information on the ENERGY STAR joint program.



NOTE: Energy Star is NOT supported on FreeDOS and Linux-based operating system.

Canadian Department of Communications Statement

This digital apparatus does not exceed the Class B limits for radio noise emissions from digital apparatus set out in the Radio Interference Regulations of the Canadian Department of Communications.

This class B digital apparatus complies with Canadian ICES-003.

This Class B digital apparatus meets all requirements of the Canadian Interference - Causing Equipment Regulations.

Cet appareil numérique de la classe B respecte toutes les exigences du Règlement sur le matériel brouiller du Canada.



TCO certified

A third-party certification according to ISO 14024



Toward sustainable IT products

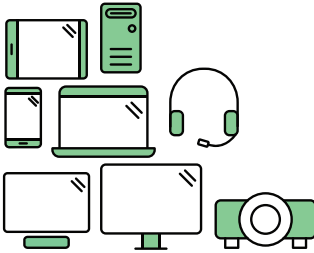

Say hello to a more sustainable product

IT products are associated with a wide range of sustainability risks throughout their life cycle. Human rights violations are common in the factories. Harmful substances are used both in products and their manufacture. Products can often have a short lifespan because of poor ergonomics, low quality and when they are not able to be repaired or upgraded.

This product is a better choice. It meets all the criteria in TCO Certified, the world's most comprehensive sustainability certification for IT products. Thank you for making a responsible product choice, that help drive progress towards a more sustainable future!

Criteria in TCO Certified have a life-cycle perspective and balance environmental and social responsibility. Conformity is verified by independent and approved verifiers that specialize in IT products, social responsibility or other sustainability issues. Verification is done both before and after the certificate is issued, covering the entire validity period. The process also includes ensuring that corrective actions are implemented in all cases of factory non-conformities. And last but not least, to make sure that the certification and independent verification is accurate, both TCO Certified and the verifiers are reviewed regularly.

Want to know more?

Read information about TCO Certified, full criteria documents, news and updates at [tcocertified.com](https://www.tcocertified.com). On the website you'll also find our Product Finder, which presents a complete, searchable listing of certified products.

Safety information

- Before setting up the monitor, carefully read all the documentation that came with the package.
- To prevent fire or shock hazard, never expose the monitor to rain or moisture.
- Never try to open the monitor cabinet. The dangerous high voltages inside the monitor may result in serious physical injury.
- If the power supply is broken, do not try to fix it by yourself. Contact a qualified service technician or your retailer.
- Before using the product, make sure all cables are correctly connected and the power cables are not damaged. If you detect any damage, contact your dealer immediately.
- Slots and openings on the back or top of the cabinet are provided for ventilation. Do not block these slots. Never place this product near or over a radiator or heat source unless proper ventilation is provided.
- The monitor should be operated only from the type of power source indicated on the label. If you are not sure of the type of power supply to your home, consult your dealer or local power company.
- Use the appropriate power plug which complies with your local power standard.
- Do not overload power strips and extension cords. Overloading can result in fire or electric shock.
- Avoid dust, humidity, and temperature extremes. Do not place the monitor in any area where it may become wet. Place the monitor on a stable surface.
- Unplug the unit during a lightning storm or if it will not be used for a long period of time. This will protect the monitor from damage due to power surges.
- Never push objects or spill liquid of any kind into the slots on the monitor cabinet.
- To ensure satisfactory operation, use the monitor only with UL listed computers which have appropriate configured receptacles marked between 100-240V AC.
- If you encounter technical problems with the monitor, contact a qualified service technician or your retailer.
- Adjustment of the volume control as well as the equalizer to other settings than the center position may increase the ear-/headphones output voltage and therefore the sound pressure level.



This symbol of the crossed out wheeled bin indicates that the product (electrical, electronic equipment, and mercury-containing button cell battery) should not be placed in municipal waste. Please check local regulations for disposal of electronic products.

AEEE yönetmeliğine uygundur

Care & Cleaning

- Before you lift or reposition your monitor, it is better to disconnect the cables and power cord. Follow the correct lifting techniques when positioning the monitor. When lifting or carrying the monitor, grasp the edges of the monitor. Do not lift the display by the stand or the cord.
- Cleaning. Turn your monitor off and unplug the power cord. Clean the monitor surface with a lint-free, non-abrasive cloth. Stubborn stains may be removed with a cloth dampened with mild cleaner.
- Avoid using a cleaner containing alcohol or acetone. Use a cleaner intended for use with the monitor. Never spray cleaner directly on the screen, as it may drip inside the monitor and cause an electric shock.

The following symptoms are normal with the monitor:

- You may find slightly uneven brightness on the screen depending on the desktop pattern you use.
- When the same image is displayed for hours, an afterimage of the previous screen may remain after switching the image. The screen will recover slowly or you can turn off the Power Switch for hours.
- When the screen becomes black or flashes, or cannot work anymore, contact your dealer or service center to fix it. Do not repair the screen by yourself!

Conventions used in this guide



WARNING: Information to prevent injury to yourself when trying to complete a task.



CAUTION: Information to prevent damage to the components when trying to complete a task.



IMPORTANT: Information that you **MUST** follow to complete a task.



NOTE: Tips and additional information to aid in completing a task.

Where to find more information

Refer to the following sources for additional information and for product and software updates.

1. ASUS websites

The ASUS websites worldwide provide updated information on ASUS hardware and software products. Refer to <http://www.asus.com>

2. Optional documentation

Your product package may include optional documentation that may have been added by your dealer. These documents are not part of the standard package.

Takeback Services

ASUS recycling and takeback programs come from our commitment to the highest standards for protecting our environment. We believe in providing solutions for our customers to be able to responsibly recycle our products, batteries and other components as well as the packaging materials.

Please go to <http://csr.asus.com/english/Takeback.htm> for detail recycling information in different region.

Product information for EU energy label



PA278QV

1.1 Welcome!

Thank you for purchasing the ASUS® LCD monitor!

The latest widescreen LCD monitor from ASUS provides a broader, brighter and crystal-clear display, plus a host of features that enhance your viewing experience.

With these features, you can enjoy the convenience and delightful visual experience that the monitor brings to you!

1.2 Package contents

Check your package for the following items:

- ✓ LCD monitor
- ✓ Monitor base
- ✓ Quick start guide
- ✓ Warranty card
- ✓ Power cord
- ✓ HDMI cable (optional)
- ✓ DisplayPort cable (optional)
- ✓ DisplayPort cable (mini DP to DP) (optional)
- ✓ USB B to A cable (optional)
- ✓ Audio cable (optional)
- ✓ Color calibration testing report
- ✓ ProArt welcome card



If any of the above items is damaged or missing, contact your retailer immediately.



1.3 Monitor introduction

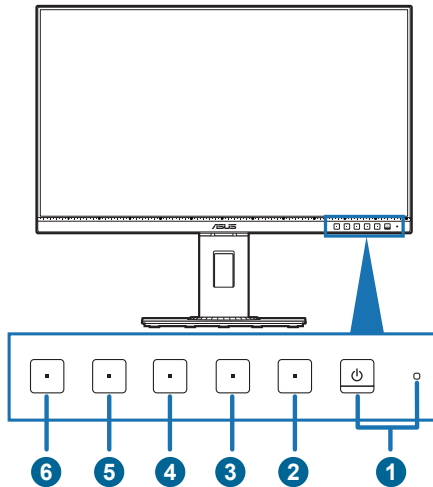

1.3.1 Front view



1.  Power button/power indicator
 - Turns the monitor on/off.
 - The color definition of the power indicator is as the below table.

Status	Description
White	On
Amber	Standby mode
Off	Off

2.  Menu button:
 - Press this button to display the OSD menu when the OSD is off.
 - Enters the OSD menu.
 - Toggles the Key Lock function between on and off with a long press for 5 seconds.
3.  Close button:
 - Press this button to display the OSD menu when the OSD is off.
 - Exits the OSD menu.
4.  QuickFit button:
 - Press this button to display the OSD menu when the OSD is off.
 - This is a hotkey to activate the QuickFit function designed for alignment.
 - The QuickFit function contains pages of common grid patterns, paper sizes, and photo sizes. (Please refer to 3.1.2 OSD function introduction).

5.  **Shortcut 1**
 - Press this button to display the OSD menu when the OSD is off.
 - Default: Brightness hotkey
 - To change the hotkey function, go to the Shortcut > Shortcut 1 menu.
6.  **Shortcut 2**
 - Press this button to display the OSD menu when the OSD is off.
 - Default: Blue light filter hotkey
 - To change the hotkey function, go to the Shortcut > Shortcut 2 menu.

1.3.2 Back view

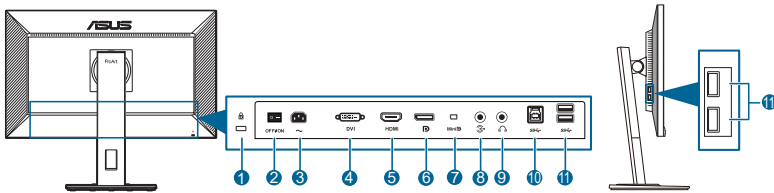

1. **Kensington lock slot.**
2. **Power switch.** Press the switch to turn on/off power.
3. **AC-IN port.** This port connects the power cord.
4. **DVI port.** This 24-pin port is for PC (Personal Computer) DVI-D digital signal connection.
5. **HDMI port.** This port is for connection with an HDMI compatible device.
6. **DisplayPort in.** This port is for connection with a DisplayPort compatible device.
7. **Mini DisplayPort in.** This port is for connection with a Mini DisplayPort compatible device.
8. **Audio-in port.** This port connects PC audio source by the bundled audio cable.
9. **Earphone jack.** This port is only available when an HDMI/DisplayPort cable is connected.
10. **USB 3.2 Gen 1 Type-B.** This port is for connection with a USB upstream cable. The connection enables the USB ports on the monitor.
11. **USB 3.2 Gen 1 Type-A.** These ports are for connection with USB devices, such as USB keyboard/mouse, USB flash drive, etc.

2.1 Assembling the monitor arm/base

To assemble the monitor base:

1. Have the front of the monitor face down on a table.
2. Place the arm hinge of the stand assembly onto its compartment on the rear of the monitor (for selected models).
3. Attach the base into the arm, making sure the tab on the arm fits into the groove on the base.
4. Fix the base to the arm by fastening the bundled screw.



We recommend that you cover the table surface with soft cloth to prevent damage to the monitor.

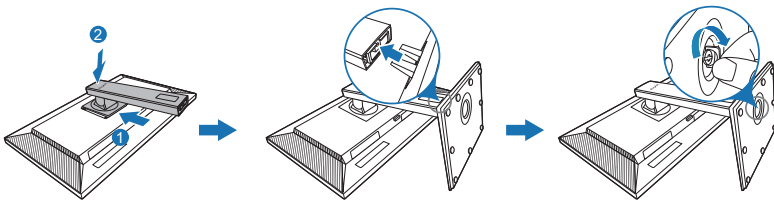

(For selected models)



Base screw size: M6 x 16.2 mm.

2.2 Detaching the arm/base (for VESA wall mount)

The detachable arm/base of this monitor is specially designed for VESA wall mount.

To detach the arm/base:

1. Have the front of the monitor face down on a table.
2. Press the release button, and then detach the arm/base from the monitor (Figure 1).

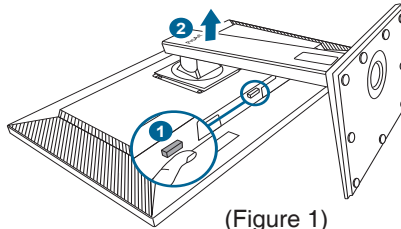

(Figure 1)



We recommend that you cover the table surface with soft cloth to prevent damage to the monitor.



- The VESA wall mount kit (100 x 100 mm) is purchased separately.
 - Use only the UL Listed Wall Mount Bracket with minimum weight/load 22.7kg (Screw size: M4 x 10 mm)
-

2.3 Adjusting the monitor

- For optimal viewing, we recommend that you look at the full face of the monitor, then adjust the monitor to the angle that is most comfortable for you.
- Hold the stand to prevent the monitor from falling when you change its angle.
- You can adjust the monitor's angle from $+35^{\circ}$ to -5° and it allows 90° swivel adjustment from either left or right. You can also adjust the monitor's height within ± 150 mm.

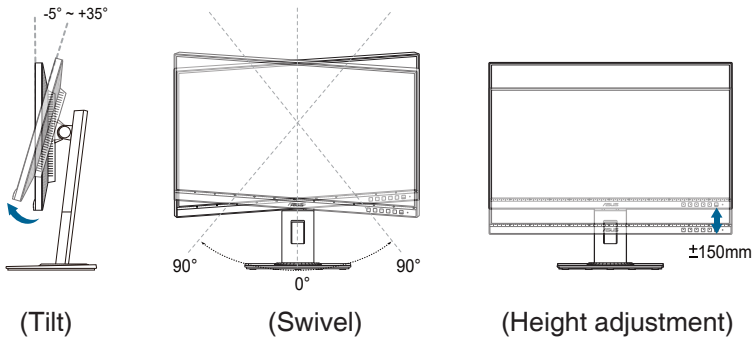

Pivoting the monitor

1. Lift the monitor to the highest position.
2. Tilt the monitor to its maximum angle.
3. Pivot the monitor clockwise/counterclockwise to the angle you need.

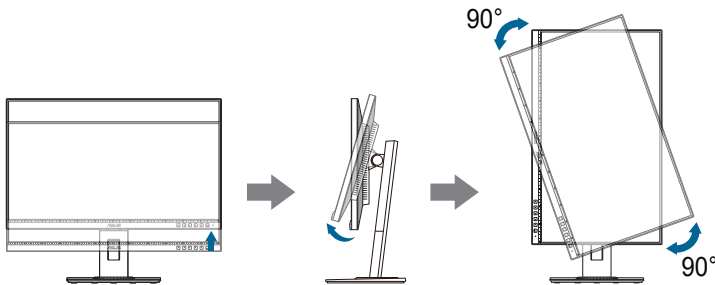

It is normal that the monitor slightly shakes while you adjust the viewing angle.

2.4 Connecting the cables

Connect the cables as the following instructions:

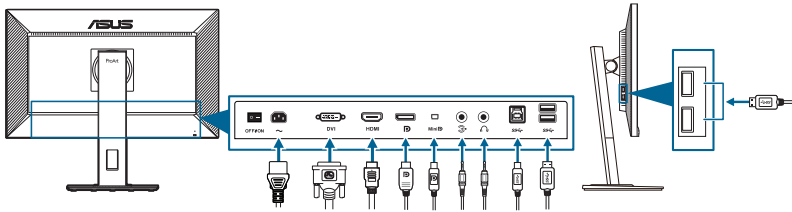



- **To connect the power cord:** Connect one end of the power cord securely to the monitor's AC input port, the other end to a power outlet.
- **To connect the DVI/DisplayPort/mini DisplayPort/HDMI cable:**
 - a. Plug one end of the DVI/DisplayPort/mini DisplayPort/HDMI cable to the monitor's DVI/DisplayPort/mini DisplayPort/HDMI jack.
 - b. Connect the other end of the DVI/DisplayPort/mini DisplayPort/HDMI cable to your computer's DVI/DisplayPort/mini DisplayPort/HDMI jack.
 - c. Tighten the two screws to secure the DVI connector.
- **To connect the audio cable:** connect one end of the audio cable to the monitor's Audio-in port, the other end to the computer's audio-out port.
- **To use the earphone:** connect the end with plug type to the monitor's earphone jack when an HDMI/DisplayPort signal is fed.
- **To use the USB 3.2 Gen 1 ports:**
 - » Upstream: Use the supplied USB Type-B to Type-A cable. Make sure your computer is installed with the latest Windows 7/Windows 8.1/Windows 10 operating system. That will enable the USB ports on the monitor to work.
 - » Downstream: Plug the USB Type-A cable of your device to the monitor's USB Type-A jack.



When these cables are connected, you can choose the desired signal from the Input Select item in the OSD menu.

2.5 Turning on the monitor

Press the power button . See page 1-2 for the location of the power button. The power indicator  lights up in white to show that the monitor is ON.

3.1 OSD (On-Screen Display) menu

3.1.1 How to reconfigure

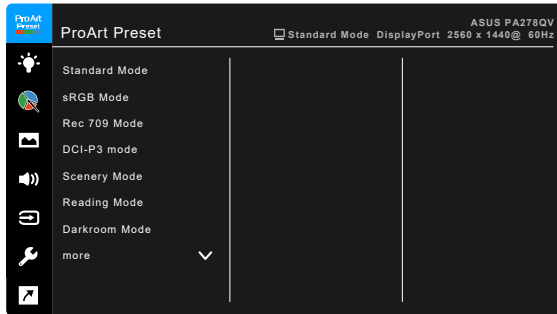

1. Press any button (except the Power button) to display the OSD menu.
2. Press the Menu button to activate the OSD menu.
3. Press the buttons as indicated on the screen to navigate through the functions. Highlight the desired function and press to activate it. If the function selected has a sub-menu, press and again to navigate through the sub-menu functions. Highlight the desired sub-menu function and press to activate it.
4. Press and to change the settings of the selected function.
5. To exit and save the OSD menu, press or repeatedly until the OSD menu disappears. To adjust other functions, repeat steps 1-4.

3.1.2 OSD function introduction

1. ProArt Preset

This function contains 10 sub-functions you can select for your preference. Each mode has the Reset selection, allowing you to maintain your setting or return to the preset mode.

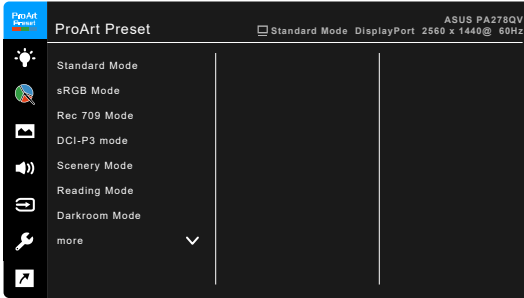

- **Standard Mode:** Best choice for document editing.
- **sRGB Mode:** Compatible with sRGB color space, sRGB mode is the best choice for document editing.



sRGB Mode meets Energy Star® requirements.

- **Rec. 709 Mode:** Compatible with Rec. 709 color space.
- **DCI-P3 Mode:** Compatible with DCI-P3 color space.
- **Scenery Mode:** Best choice for scenery photo display.
- **Reading Mode:** This is the best choice for book reading.
- **Darkroom Mode:** This is the best choice for a weak ambient light environment.
- **Rapid Rendering Mode:** Simulates display as high refresh rate performance to generate different backlight frequencies.



Rapid Rendering Mode can only be activated at 75Hz.



To activate this function, you need to do the following: turn off Adaptive-Sync. Brightness, Blue Light Filter, ASCR, Trace Free cannot be adjusted when using this function.

- **User Mode 1/User Mode 2:** Allows you to make color adjustments in the Advanced Setting.

Below table shows the default configurations for each ProArt Preset mode:

Function	Standard Mode	sRGB Mode	Rec. 709 Mode	DCI-P3 Mode	Scenery Mode	Reading Mode	Darkroom Mode	Rapid Rendering Mode	User Mode 1/User Mode 2
Color Temp.	6500K	Fixed 6500K	6500K	Enable (P3-Theater)	6500K	Disable	6500K	6500K	6500K
Brightness	50	Fixed 100 nits	100 nits	Enable (50)	100	Enable (8)	Enable (0)	50	50
Contrast	80	Fixed 80	80	Enable (80)	80	Disable (80)	80	80	80
ASCR	Disable	Disable	Disable	Disable	Off	Disable	Off	Disable	Disable
Sharpness	Enable (0)	Enable (0)	Enable (0)	Enable (0)	Enable (0)	Enable (0)	Enable (0)	Enable (0)	Enable (0)
Saturation	Middle (50)	Disable	Middle (50)	Enable (50)	Middle (50)	Disable	Middle (50)	Middle (50)	Middle (50)
Hue	Middle (50)	Disable	Middle (50)	Enable (50)	Middle (50)	Disable	Middle (50)	Middle (50)	Middle (50)
Color	Enable (Default)	Disable	Enable (Default)	Enable	Enable (Default)	Enable (Default)	Enable (Default)	Enable (Default)	Enable (Default)
Gamma	Enable (2.2)	Fixed (2.2)	Enable (2.4)	Disable	Disable	Enable (2.2)	Enable (2.2)	Enable (2.2)	Enable (2.2)
VividPixel	0	0	0	0	0	0	0	0	0

2. Blue Light Filter

In this function, you can adjust the blue light filter level.

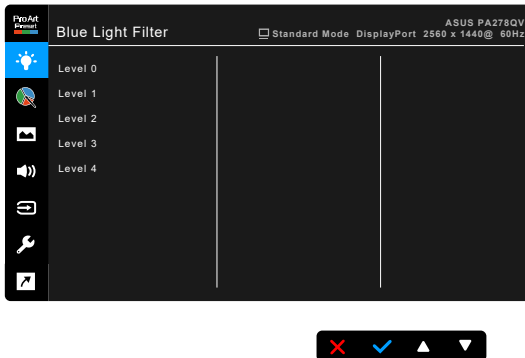

- **Level 0:** No change.
- **Level 1~4:** The higher the level, the less blue light is scattered. When Blue Light Filter is activated, the default settings of Standard Mode will be automatically imported. Between Level 1 to Level 3, the Brightness function is user-configurable. Level 4 is optimized setting. It is in compliance with TUV Low Blue Light Certification. The Brightness function is not user-configurable. Enabling this function automatically turns off ECO Mode.



Please refer to the following to alleviate eye strains:

- Users should take some time away from the display if working for long hours. It is advised to take short breaks (at least 5 mins) after around 1 hour of continuous working at the computer. Taking short and frequent breaks is more effective than a single longer break.
- To minimize eye strain and dryness in your eyes, users should rest the eye periodically by focusing on objects that are far away.
- Eye exercises can help to reduce eye strain. Repeat these exercises often. If eye strain continues please consult a physician. Eye exercises: (1) Repeating look up and down (2) Slowly roll your eyes (3) Move your eyes diagonal.
- High energy blue light may lead to eye strain and AMD (Age-Related Macular Degeneration). Blue light Filter to reduce 70% (max.) harmful blue light to avoiding CVS (Computer Vision Syndrome).

3. ProArt Palette

Set a desired color setting from this menu.



- **Brightness:** The adjusting range is from 0 to 100.
- **Contrast:** The adjusting range is from 0 to 100.
- **Saturation:** The adjusting range is from 0 to 100.
- **Hue:** Shifts the image color between green and purple.
- **Color Temp.:** Contains 5 modes including 9300K, 6500K, 5500K, 5000K and P3-Theater.
- **Gamma:** Allows you to set the color mode to 2.6, 2.4, 2.2, 2.0 or 1.8 (Mac).
- **Black Level:** To adjust the initialized 1st signal level of darkest gray level.
- **Color:**
 - * Six-axis Hue adjustment.
 - * Six-axis Saturation adjustment.

- * Adjusts the gain levels for R, G, B.
- * Adjusts the black level offset values for R, G, B.
- **Color Reset:**
 - * Current mode color reset:
Resets the color settings of current color mode to the factory default value.
 - * All modes color reset:
Resets the color settings of all color modes to the factory default value.

4. Image

Set the image related setting from this menu.

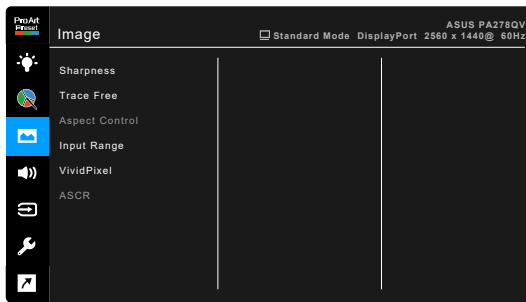

- **Sharpness:** The adjusting range is from 0 to 100.
- **Trace Free:** Adjusts the response time of the monitor.
- **Aspect Control:** Adjusts the aspect ratio to full, 4:3, or OverScan.



4:3 is only available when input source is in 4:3 format. OverScan is only available for the HDMI input source.

- **Input Range:** To map signal range with whole black to white presented range of display.
- **VividPixel:** Enhances the outline of the displayed picture and generates high-quality images on screen.
- **ASCR:** Turns on/off the ASCR (ASUS Smart Contrast Ratio) function.

5. Sound

You can adjust Volume, Mute and Source from this menu.

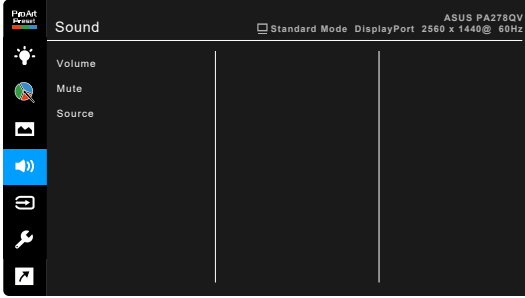

- **Volume:** the adjusting range is from 0 to 100.
- **Mute:** toggles the monitor sound between on and off.
- **Source:** decides the monitor sound comes from which source.

6. Input Select

In this function, you can select your desired input source.

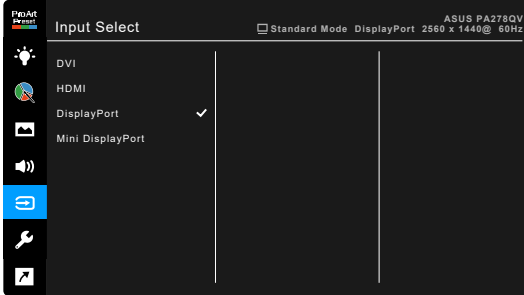

7. System Setup

Allows you to adjust the system.

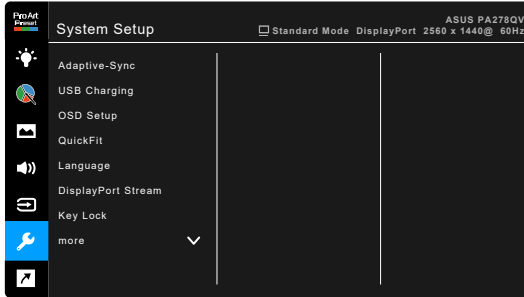

- **Adaptive-Sync** (DisplayPort/HDMI only): Allows an Adaptive-Sync supported* graphics source to dynamically adjust display refresh rate based on typical content frame rates for power efficient, virtually stutter free and low-latency display update.



* Adaptive-Sync can only be activated within 48Hz ~ 75Hz.

* For supported GPUs, minimum PC system and driver requirements, please contact the GPU manufactures.

To activate this function, you need to do the following: set DisplayPort Stream to DisplayPort 1.2.

- **USB Charging:**

- * “On During Standby” allows the USB downstream ports to charge external devices when the monitor is turned on or in standby mode.
- * “Off During Standby” allows the USB downstream ports to charge external devices only when the monitor is turned on.



Only USB downstream port BC1.2 is able to charge without upstream cable connected.

- **OSD Setup:**

- * Adjusts the OSD timeout from 10 to 120 seconds.
- * Enables or disables the DDC/CI function.
- * Adjusts the OSD background from opaque to transparent.

- **QuickFit:** Allows users to have a preview of the document or photo layout directly on screen without printing test copies.

- * **Ruler:** This pattern presents physical ruler on top and left side. You can press the ↵ Return button for longer than 3 seconds to switch the measurements between metric and imperial.



- * **Alignment:** Facilitates designers and users to organize content and layout on one page and achieve a consistent look and feel.

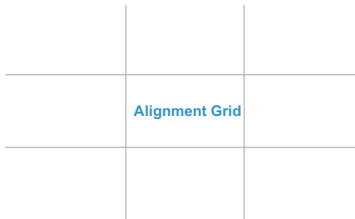

- * **A4:** Provides users to view their documents in real size on the screen.

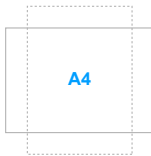

- * **B5:** Provides users to view their documents in real size on the screen.



- **Language:** There are 21 languages for your selection, including English, French, German, Italian, Spanish, Dutch, Portuguese, Russian, Czech, Croatian, Polish, Romanian, Hungarian, Turkish, Simplified Chinese, Traditional Chinese, Japanese, Korean, Thai, Indonesian, Persian.

- **DisplayPort Stream:** Compatibility with graphic card. Select DisplayPort 1.1 or DisplayPort 1.2 by graphic card DP version.
- **Key Lock:** To disable all function keys. Press the second button from the right over five seconds to cancel the key lock function.
- **Power Indicator:** Turns the power LED indicator on/off.
- **Information:** Shows the monitor information.
- **All Reset:** “Yes” allows you to restore the default settings.

8. Shortcut

Defines the functions for Shortcut 1 and 2 buttons.

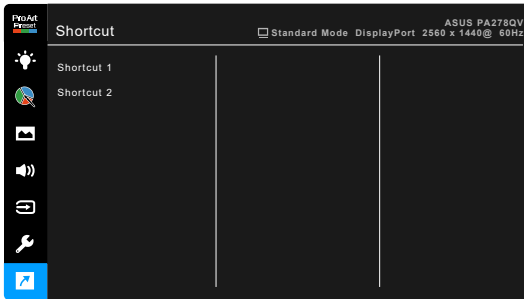

- **Shortcut 1/Shortcut 2:** Selects a function for Shortcut 1 and 2 buttons.



When a certain function is selected or activated, your shortcut key may not support. Available function choices for shortcut: Blue Light Filter, Brightness, Contrast, Color Temp., QuickFit, User Mode 1, User Mode 2.

3.2 Specifications summary

Panel Type	TFT LCD
Panel size	27" (16:9, 68.47 cm) wide screen
Max. Resolution	2560 x 1440
Pixel pitch	0.2331 mm x 0.2331 mm
Brightness (Typ.)	350 cd/m ²
Contrast Ratio (Typ.)	1000:1
Contrast Ratio (Max.)	100,000,000:1 (with ASCR on)
Viewing angle (H/V) CR>10	178°/178°
Display colors	16.7 M
Response time	≤ 5 ms (grey to grey)
ProArt Preset selection	10 color preset modes
Auto adjustment	No
Color temperature selection	5 color temperatures
Analog input	No
Digital input	DisplayPort v1.2, mini DisplayPort, HDMI v1.4, DVI-D with HDCP
Digital Output	No
Earphone jack	Yes
Audio input	Yes
Speaker (Built-in)	PA278QV: 2 W x 2 Stereo, RMS PA278QEV: No
USB 3.2 Gen 1 port	1 x USB 3.2 Gen 1 Type-B, 4 x USB 3.2 Gen 1 Type-A
Colors	Black
Power LED	White (On)/Amber (Standby)
Tilt	+35° ~ -5°
Pivot	+90° ~ -90°
Swivel	+90° ~ -90°
Height Adjustment	150 mm
Kensington lock	Yes
AC input voltage	AC: 100~240V
Power consumption	Power On: < 20.3 W** (Typ.), Standby: < 0.5 W (Typ.), Power Off: 0 W (Switch off)
Temperature (Operating)	0°C~40°C
Temperature (Non-operating)	-20°C~+60°C
Dimension (W x H x D) without stand	615 x 372 x 51 mm
Dimension (W x H x D) with stand	615 x 532 x 226 mm (highest), 615 x 382 x 226 mm (lowest),
Dimension (W x H x D)	828 x 162 x 495 mm (package)
Weight (Esti.)	6.9 kg (Net); 4.7 kg (without stand); 9.2 kg (Gross)

Multi-languages	21 languages (English, French, German, Italian, Spanish, Dutch, Portuguese, Russian, Czech, Croatian, Polish, Romanian, Hungarian, Turkish, Simplified Chinese, Traditional Chinese, Japanese, Korean, Thai, Indonesian, Persian)
Accessories	Quick start guide, warranty card, power cord, HDMI cable (optional), DisplayPort cable (optional), USB B to A cable (optional), audio cable (optional), DisplayPort cable (mini DP to DP) (optional), color calibration testing report, ProArt welcome card
Compliance and Standards	PA278QV: UL/cUL, FCC, ICES-3, CB, CE, ErP, WEEE, TUV-GS, TUV-Ergo, ISO 9241-307, UkrSEPRO, CU, CCC, CEL, BSMI, RCM, MEPS, VCCI, PSE, PC Recycle, J-MOSS, KC, KCC, e-Standby, Energy Star®, RoHs, Windows 7/8.1/10 WHQL, Flicker Free, Low Blue Light, Add PSB, TCO, CEC PA278QEV: CCC, CEL, BSMI

*Specifications are subject to change without notice.

**Measuring a screen brightness of 200 nits without audio/USB/Card reader connection.

3.3 Outline dimensions

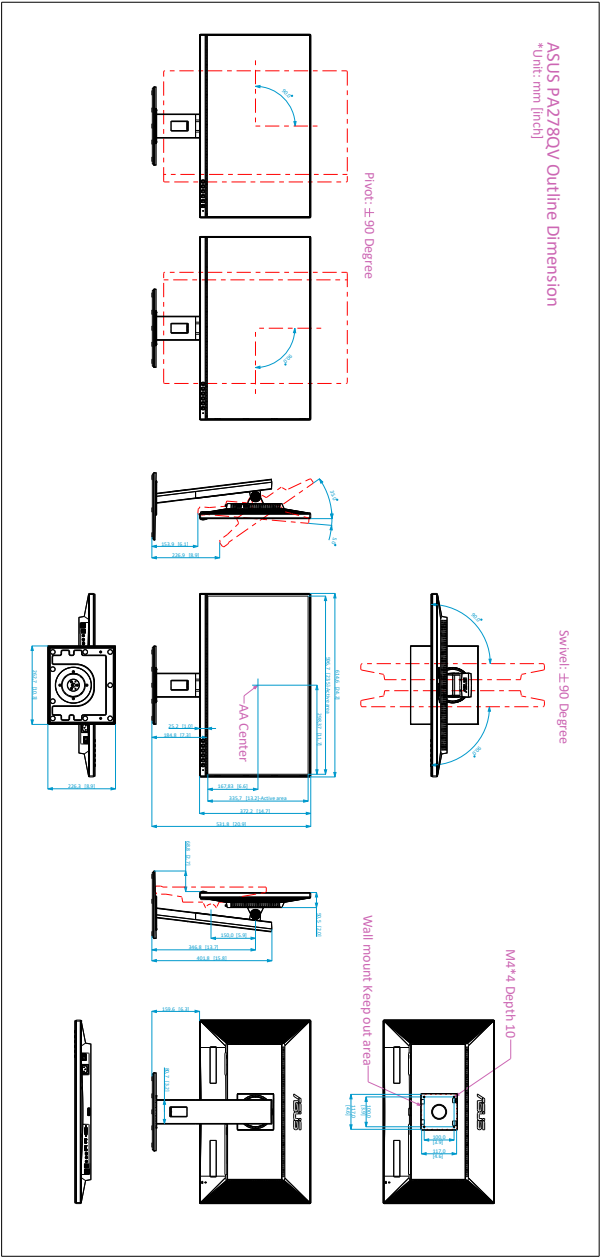

3.4 Troubleshooting (FAQ)

Problem	Possible Solution
Power LED is not ON	<ul style="list-style-type: none"> • Press the  button to check if the monitor is in the ON mode. • Check if the power cord is properly connected to the monitor and the power outlet. • Check if the power switch is ON.
The power LED lights amber and there is no screen image	<ul style="list-style-type: none"> • Check if the monitor and the computer are in the ON mode. • Make sure the signal cable is properly connected the monitor and the computer. • Inspect the signal cable and make sure none of the pins are bent. • Connect the computer with another available monitor to check if the computer is properly working.
Screen image is too light or dark	<ul style="list-style-type: none"> • Adjust the Contrast and Brightness settings via OSD.
Screen image is not centered or sized properly	<ul style="list-style-type: none"> • Adjust the H-Position or V-Position settings via OSD.
Screen image bounces or a wave pattern is present in the image	<ul style="list-style-type: none"> • Make sure the signal cable is properly connected to the monitor and the computer. • Move electrical devices that may cause electrical interference.
Screen image has color defects (white does not look white)	<ul style="list-style-type: none"> • Inspect the signal cable and make sure that none of the pins are bent. • Perform All Reset via OSD. • Adjust the R/G/B color settings or select the Color Temperature via OSD.
Screen image is blurry or fuzzy	<ul style="list-style-type: none"> • Adjust the Phase and Clock settings via OSD.
No sound or sound is low	<ul style="list-style-type: none"> • Ensure that the HDMI/DisplayPort cable is properly connected to the monitor and the computer. • Adjust the volume settings of both your monitor and HDMI/DisplayPort device. • Ensure that the computer sound card driver is properly installed and activated.

3.5 Supported operating modes

Resolution	Frequency	Horizontal Frequency (KHz)	Vertical Frequency (Hz)	Pixel (MHz)
640x480		31.47(N)	59.94(N)	25.18
640x480		35.00(N)	66.66(N)	30.24
640x480		37.87(N)	72.82(N)	31.5
640x480		37.5(N)	75.00(N)	31.5
720x400		31.47(N)	70.08(P)	28.32
800x600		35.16(P)	56.25(P)	36
800x600		37.88(P)	60.32(P)	40
800x600		46.86(P)	75.00(P)	49.5
1024x768		48.36(N)	60.00(N)	65
1024x768		56.476(N)	70.069(N)	75
1024x768		60.02(N)	75.00(N)	78.75
1152x864		67.5(P/N)	75.00(P/N)	108
1280x720		45.00(P)	60.00(N)	74.25
1280x768		47.78(P)	60.00(N)	79.5
1280x800		49.7(P)	60.00(N)	83.5
1280x960		60.00(P)	60.00(N)	108
1280x1024		63.98(P)	60.02(P)	108
1280x1024		79.98(P)	75.02(P)	135
1440x900		55.94(N)	59.89(P)	106.5
1600x1200		75.00(P)	60.00(P)	162
1680x1050		65.29(N)	60.00(P)	146.25
1920x1080		67.5(P)	60.00(P)	148.5
1920x1200 (Reduced Blanking)		74.038(P)	59.95(N)	154
1920x1200		74.556(N)	59.885(P)	193.25
2048x1152(Reduce blanking)		70.99(P)	59.9(N)	156.75
2560x1080		66.636(P)	59.978(N)	181.25
2560x1440		88.787(P)	59.951(N)	241.5
2560x1440		111.786(P)	74.924(N)	298.47

“P” / “N” stands for “Positive” / “Negative” polarity of incoming H-sync/V-sync (input timing).
 When the monitor is operating in the video mode (ie, not displaying data), the following high definition modes shall be supported in addition to standard definition video.

Timing Name	Pixel Format	Horizontal Frequency (kHz)	Vertical Frequency (Hz)	Pixel Rate (MHz)
480p	720 x 480	31.469	60	27
720p60	1280 x 720	45	60	74.25
576p	720 x 576	31.25	50	27
720p50	1280 x 720	37.5	50	74.25
1080p24	1920 x 1080	27	24	74.25
1080p25	1920 x 1080	28.125	25	74.25
1080p60	1920 x 1080	67.5	60	148.5
1080p50	1920 x 1080	56.25	50	148.5